

Ventilating Fan Specifications

Model : FV-20AU9T

Specifications

			110V 50Hz	110V 60Hz	127V 60Hz
			Exhaust	Exhaust	Exhaust
Air Volume	m ³ /h	±10%	530	550	680
Power Consumption	W	±12%	21.0	21.0	26.0
Ampere	A	±12%	0.21	0.20	0.22
Noise	dB (A)	+3/-7	35.0	37.0	42.0
*Rotation Speed	min ⁻¹		1150	1175	1405

*Rotation Speed data are reference only.

1. Power Rating ----- 110V~ 50Hz / 110-127V~ 60Hz
2. Motor Type ----- Capacitor start and run induction motor
3. Blade Type ----- 200mm dia. propeller fan
4. Ambient Temperature ----- -10 to 40 deg.C
5. Insulation Resistance ----- More than 10meg ohm
6. Electrical Strength ----- 1500V~ 1 minute
7. Net Weight ----- 2.0 Kg
8. Insulation Class ----- Class E

Drawing with dimensions (Unit: mm)

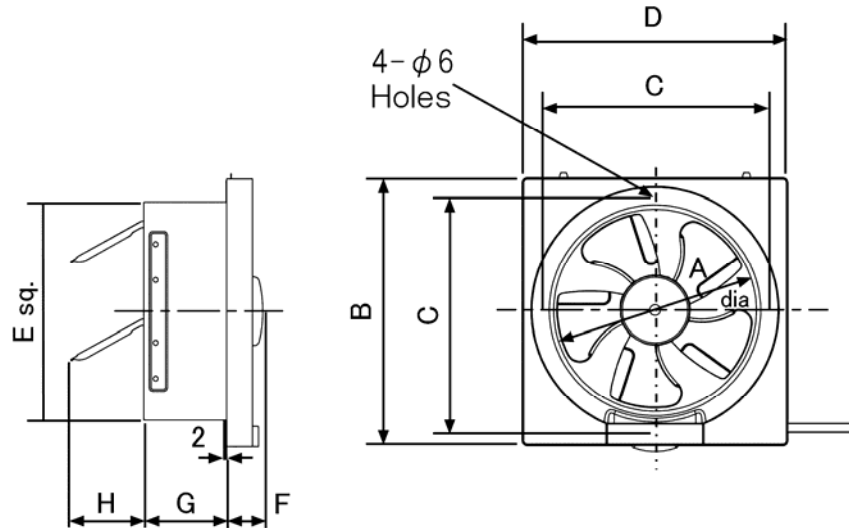

Model	A	B	C	D	E	F	G	H
FV-20AU9T	200	306	260	302	240	52	90	80

Circuit diagram

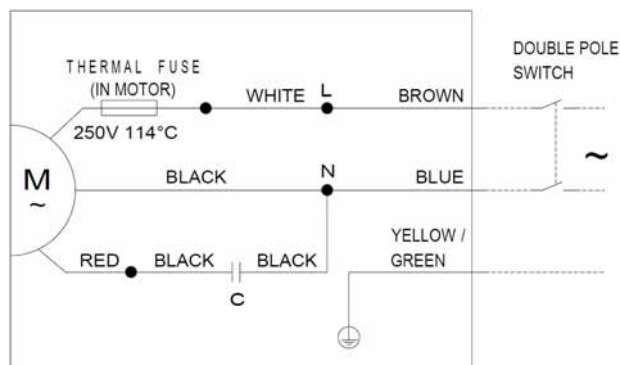

Ventilating Fan Specifications

Model : FV-20AU9T

Specifications

			220V 50Hz	230V 50Hz	240V 50Hz	220V 60Hz	230V 60Hz
			Exhaust	Exhaust	Exhaust	Exhaust	Exhaust
Air Volume	m ³ /h	±10%	580	610	620	650	710
Power Consumption	W	±12%	20.0	21.0	23.0	24.0	25.5
Ampere	A	±12%	0.10	0.10	0.11	0.11	0.11
Noise	dB (A)	+3/-7	37.5	38.0	38.0	41.5	42.0
*Rotation Speed	min ⁻¹		1250	1270	1290	1400	1480

*Rotation Speed data are reference only.

1. Power Rating ----- 220-240V~ 50Hz / 220-230V~ 60Hz
2. Motor Type ----- Capacitor start and run induction motor
3. Blade Type ----- 200mm dia. propeller fan
4. Ambient Temperature ----- -10 to 40 deg.C
5. Insulation Resistance ----- More than 10meg ohm
6. Electrical Strength ----- 1500V~ 1 minute
7. Net Weight ----- 2.0 Kg
8. Insulation Class ----- Class E

Drawing with dimensions (Unit: mm)

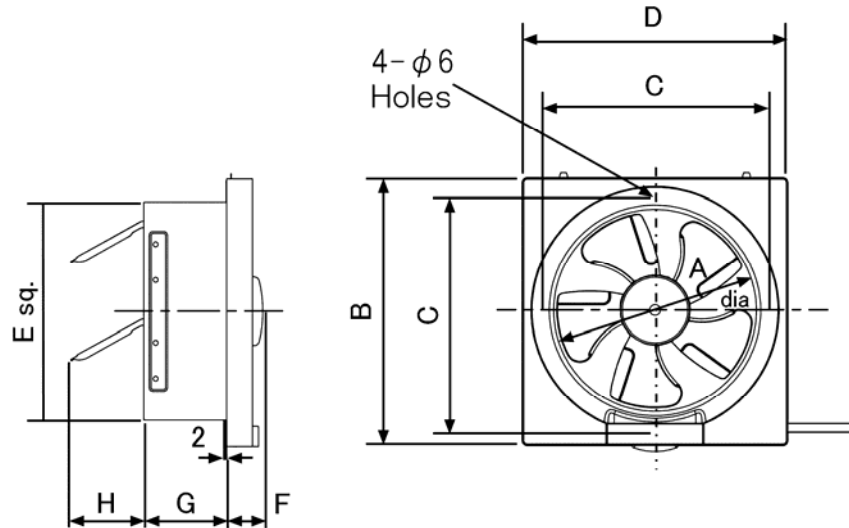

Model	A	B	C	D	E	F	G	H
FV-20AU9T	200	306	260	302	240	52	90	80

Circuit diagram

