

Ventilating Fan Specifications

Model FV-60GS4

		110V		120V		127V		220V		230V		240V
		50Hz	60Hz	50Hz	60Hz	50Hz	60Hz	50Hz	60Hz	50Hz	60Hz	50Hz
Air Volume	CMH \pm 10%	8,460	9,510	8,460	9,600	8,520	9,720	8,400	9,660	8,460	9,680	8,490
Power Consumption	W \pm 15%	232	330	248	350	259	359	245	361	258	370	263
Current	A \pm 15%	2.60	3.10	2.60	3.00	2.70	2.90	1.30	1.60	1.30	1.60	1.40
Speed	R/M \pm 10%	970	1,140	970	1,150	980	1,160	970	1,150	970	1,160	980
Starting Current	A	12.3	10.9	13.3	11.9	13.9	12.5	6.8	6.1	7.0	6.3	7.3
Noise	dB (A)	50	54	50	54	50	54	50	54	50	54	50

at 0mmAq. Static pressure.

- | | |
|--------------------------------|--|
| 1. Power Rating ----- | 1 PASE AC 110-127V 50/60Hz
1 PASE AC 220-240V 50Hz. AC 220V-230V 60Hz |
| 2. Motor Type ----- | Capacitor start and run induction motor. Class E. 4 Poles |
| 3. Blade Type ----- | Propeller fan |
| 4. Ambient temperature ----- | - 10 to 50 deg.C |
| 5. Insulation Resistance ----- | More than 1 meg ohm |
| 6. Electric Strength ----- | AC 1500V 1 minute |
| 7. Weight ----- | 34.0 Kg |
| 8. Color ----- | White |

Performance Data

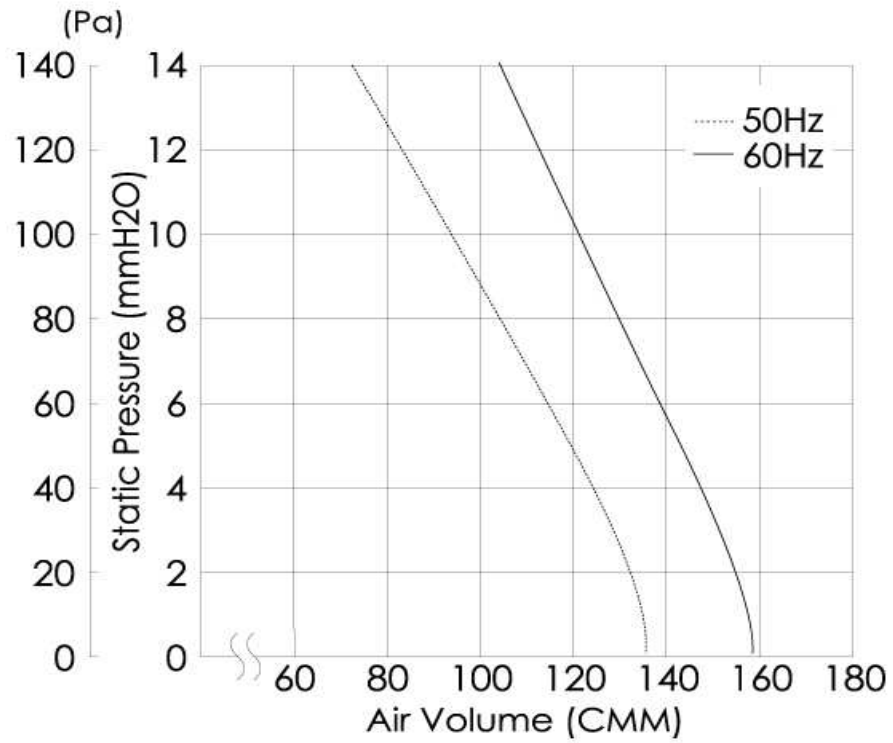

Dimension

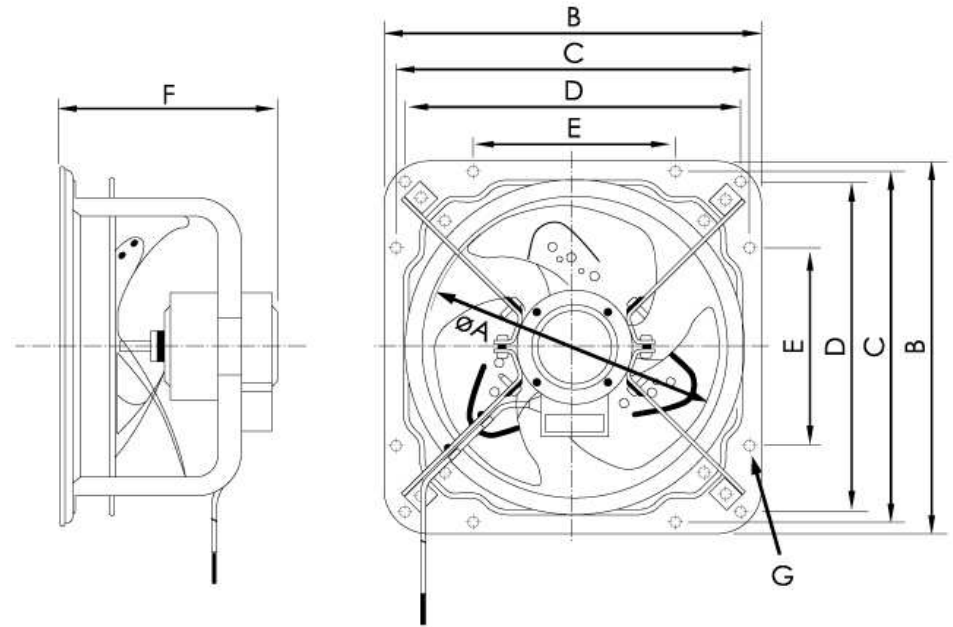

FV-60GS4	A	B	C	D	E	F	G
	620	760	720	650	400	320	15